



Figure can vary

Part no.: 68016210
MLC500T20-1050H/A
Safety light curtain transmitter



Contents

- Technical data
- Suitable receivers
- Dimensioned drawings
- Electrical connection
- Operation and display
- Part number code
- Accessories
- Notes

Technical data

Basic data	
Series	MLC 500
Device type	Transmitter
Cascading	Host
Contains	2x BT-NC sliding block
Application	Hand protection
Characteristic parameters	
Type	4, IEC/EN 61496
SIL	3, IEC 61508
SILCL	3, IEC/EN 62061
Mission time T _M	20 years, EN ISO 13849-1
Protective field data	
Resolution	20 mm
Protective field height	1,050 mm
Operating range	0 ... 15 m
Optical data	
Number of beams	84 Piece(s)
Synchronization	Optical between transmitter and receiver
Light source	LED, Infrared
LED light wavelength	940 nm
Transmitted-signal shape	Pulsed
LED group	Exempt group in acc. with EN 62471:2008
Electrical data	
Protective circuit	Overvoltage protection Short circuit protected
Performance data	
Supply voltage	26.5 ... 31.6 V
Current consumption from AS-i circuit	50 mA
Inputs	
Number of digital switching inputs	1 Piece(s)
Switching inputs	
Type	Digital switching input
Switching voltage high, min.	18 V
Switching voltage low, max.	2.5 V
Switching voltage, typ.	22.5 V
Voltage type	DC
Interface	
Type	AS-Interface Safety at Work
AS-i	
Function	Process
AS-i profile	S-0.B.F
Slave address	1..31 programmable, default=0
Cycle time acc. to AS-i specifications	Max. 5 ms

Connection	
Number of connections	2 Piece(s)
Connection 1	
Type of connection	Connector
Function	Machine interface
Thread size	M12
Material	Metal
No. of pins	5 -pin
Connection 2	
Type of connection	Cable with connector
Function	Cascade, Guest Out Cascade, Middle Guest Out
Cable length	330 mm
Sheathing material	PUR
Thread size	M12
Material	Plastic
No. of pins	8 -pin
Cable properties	
Permissible conductor cross section, typ.	0.25 mm ²
Length of connection cable, max.	100 m
Permissible cable resistance to load, max.	200 Ω

Mechanical data	
Dimension (W x H x L)	29 mm x 1,116 mm x 35.4 mm
Housing material	Metal, Aluminum
Lens cover material	Plastic / PMMA
Material of end caps	Diecast zinc
Net weight	1,275 g
Housing color	Yellow, RAL 1021
Type of fastening	Mounting bracket Swivel mount Groove mounting

Operation and display	
Type of display	LED
Number of LEDs	2 Piece(s)

Environmental data	
Ambient temperature, operation	0 ... 55 °C
Ambient temperature, storage	-30 ... 70 °C
Relative humidity (non-condensing)	0 ... 95 %

Certifications	
Degree of protection	IP 65
Protection class	III
Certifications	TÜV Süd c CSA US c TÜV NRTL US
Vibration resistance	50 m/s ²
Shock resistance	100 m/s ²
US patents	US 6,418,546 B

Classification

eCl@ss 8.0	27272704
eCl@ss 9.0	27272704
ETIM 5.0	EC002549

Suitable receivers

	Part no.	Designation	Article	Description
	68017210	MLC510R20-1050H/A	Safety light curtain receiver	Resolution: 20 mm Protective field height: 1,050 mm Response time: 19 ms Interface: AS-Interface Safety at Work Connection: Connector, M12, Metal, 5 -pin

Dimensioned drawings

All dimensions in millimeters

Calculation of the effective protective field height $H_{PFE} = H_{PFN} + B + C$

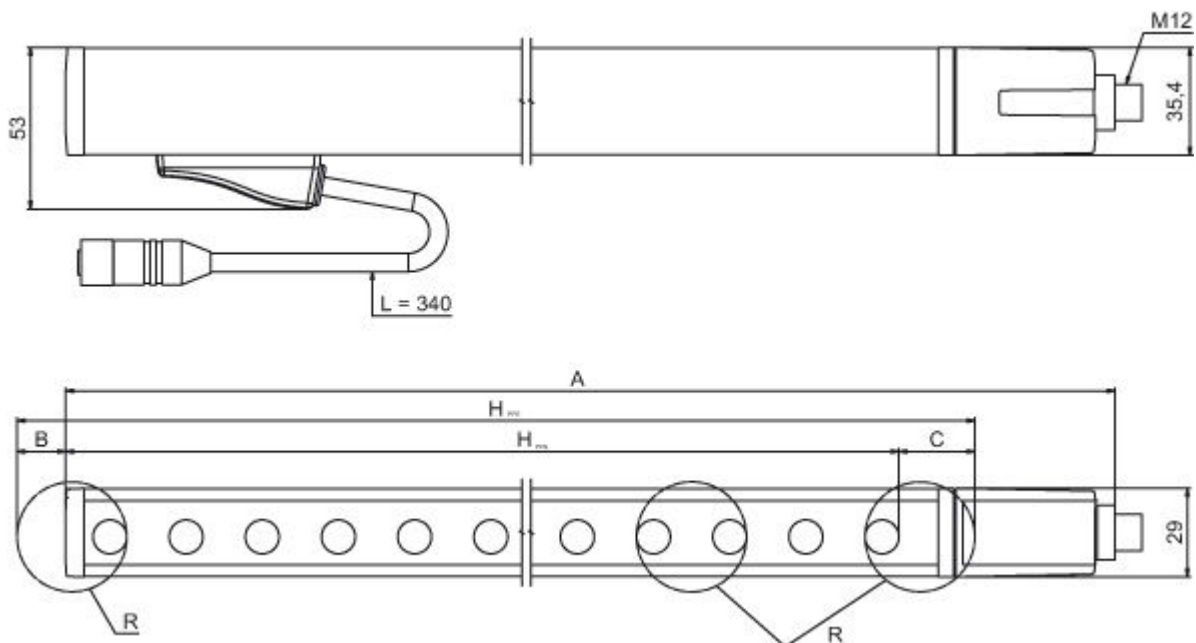

HPFE	Effective protective field height = 1067 mm
HPFN	Nominal protective field height = 1050 mm
A	Total height = 1116 mm
B	7 mm
C	10 mm
R	Effective protective field height H_{PFE} goes beyond the dimensions of the optics area to the outer borders of the circles labeled with R.

Electrical connection

Connection 1	
Type of connection	Connector
Function	Machine interface
Thread size	M12
Type	Male
Material	Metal
No. of pins	5 -pin
Encoding	A-coded

Pin	Pin assignment
1	AS-i+
2	n.c.
3	AS-i-
4	n.c.
5	n.c.



Connection 2	
Type of connection	Cable with connector
Function	Cascade, Guest Out Cascade, Middle Guest Out
Cable length	330 mm
Sheathing material	PUR
Cable color	Black
Wire cross section	0.14 mm ²
Type of stranding	Pair stranding (twisted pair)
Thread size	M12
Type	Female
Material	Plastic
No. of pins	8 -pin
Encoding	A-coded

Operation and display

LEDs

LED	Display	Meaning
1	Off	Device switched off
	Red, continuous light	Device error
	Green, continuous light	Normal operation
2		

Part number code

Part designation: MLCxyy-za-hhhhei-ooo





MLC	Safety light curtain
x	Series: 3: MLC 300 5: MLC 500
yy	Function classes: 00: Transmitter 01: transmitter (AIDA) 02: Transmitter with test input 10: Basic receiver - automatic restart 11: basic receiver - automatic restart (AIDA) 20: Standard receiver - EDM/RES selectable 30: Extended receiver - blanking/muting
z	Device type: T: transmitter R: receiver
a	Resolution: 14: 14 mm 20: 20 mm 30: 30 mm 40: 40 mm 90: 90 mm
hhh	Protective field height: 150 ... 3000: from 150 mm to 3000 mm
e	Host/Guest (optional): H: Host MG: Middle Guest G: Guest
i	Interface (optional): /A: AS-i
ooo	Option: /V: high Vibration-proof EX2: explosion protection (zones 2 + 22) SPG: Smart Process Gating

Note

A list with all available device types can be found on the Leuze electronic website at www.leuze.com.



Accessories

Mounting technology - Mounting brackets





	Part no.	Designation	Article	Description
	429056	BT-2L	Mounting bracket set	Design of mounting device: Angle, L-shape Mounting bracket, at system: Through-hole mounting Mounting bracket, at device: Screw type Material: Metal
	429006	BT-2L-HG	Mounting device set	Mounting bracket, at device: Screw type Material: Metal
	429057	BT-2Z	Mounting bracket set	Design of mounting device: Angle, Z-shape Mounting bracket, at system: Through-hole mounting Mounting bracket, at device: Screw type Material: Metal
	429005	BT-L-HG	Mounting device set	Mounting bracket, at device: Screw type Material: Metal

Part no.: 68016210 – MLC500T20-1050H/A – Safety light curtain transmitter

Mounting technology - Swivel mounts

	Part no.	Designation	Article	Description
	429393	BT-2HF	Mounting bracket set	Contains: 2x BT-HF swivel mount, 1 cylinder for mounting on the light curtain Mounting bracket, at system: Through-hole mounting Mounting bracket, at device: Clampable Type of mounting device: Turning, 360° Material: Metal, Plastic
	429394	BT-2HF-S	Mounting bracket set	Contains: 2x BT-HF swivel mount, 1 cylinder for mounting on the light curtain Mounting bracket, at system: Through-hole mounting Mounting bracket, at device: Clampable Type of mounting device: Turning, 360° Material: Metal, Plastic Shock absorber: Yes



Mounting technology - Other

	Part no.	Designation	Article	Description
	425740	BT-10NC60	Sliding block set	Contains: 10x BT-NC sliding block Bore hole 1: Ø 4.7 mm Bore hole 2: M6 Design of mounting device: Sliding block Mounting bracket, at system: Mounting thread Mounting bracket, at device: Groove mounting Material: Metal
	425741	BT-10NC64	Sliding block set	Contains: 10x BT-NC-M4-M6 sliding block Bore hole 1: M4 Bore hole 2: M6 Design of mounting device: Sliding block Mounting bracket, at system: Mounting thread Mounting bracket, at device: Groove mounting Material: Metal
	425742	BT-10NC65	Sliding block set	Contains: 10x BT-NC-M5-M6 sliding block Bore hole 1: M5 Bore hole 2: M6 Design of mounting device: Sliding block Mounting bracket, at system: Mounting thread Mounting bracket, at device: Groove mounting Material: Metal
	424422	BT-2SB10	Mounting bracket set	Contains: 2x BT-SB10 Design of mounting device: Mounting clamp Mounting bracket, at system: Through-hole mounting Mounting bracket, at device: Clampable, an der seitlichen C-Nut Type of mounting device: Swiveling Swivel range: -8 ... 8° Material: Metal
	424423	BT-2SB10-S	Mounting bracket set	Contains: 2x BT-SB10-S Design of mounting device: Mounting clamp Mounting bracket, at system: Through-hole mounting Mounting bracket, at device: Clampable, an der seitlichen C-Nut Swivel range: -8 ... 8° Material: Metal Shock absorber: Yes



Alignment aids

	Part no.	Designation	Article	Description
	427300	AC-ALM	Alignment aid	Housing material: Plastic

Part no.: 68016210 – MLC500T20-1050H/A – Safety light curtain transmitter

	Part no.	Designation	Article	Description
	520101	AC-ALM-M	Alignment aid	Housing material: Plastic
	560020	LA-78U	Alignment aid	Light source: laser, Red Housing material: Metal

Protective screens

	Part no.	Designation	Article	Description
	429038	MLC-2PSF	Mounting bracket set	Type of fastening: Clampable Mounting device material: Metal
	347077	MLC-PS1050	Protective screen	Protective field height: 1,050 mm Material: PMMA, clear

Notes

Observe intended use!

- The product may only be put into operation by competent persons.
- Only use the product in accordance with its intended use.